

# Data Sheet

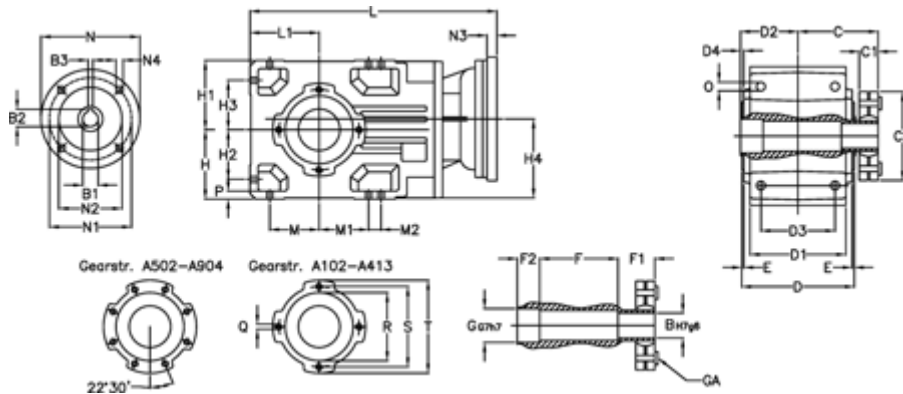

Article number: 29600100965230  
 Description: Bevel helical gearbox  
 A102US-9,6-P80B5

## Measures



B = 30	D1 = 95	F2 = 36	L = 302.0	N3 = -
B1 = 19	D2 = 60	G = 32	L1 = 70	N4 = M10x12
B2 = 21.8	D3 = 75	GA = 14,5 NM	M = 50.0	O = 9.5
B3 = 6	d4 = 4.5	H = 70	M1 = 50.0	P = 9
C = 89.5	Description = A102US-xx-P80 B5	H1 = 70	M2 = -	Q = M8x12
C1 = 23	E = 3.0	H2 = 50.0	N = 200	R = 80
C2 = 72.0	F = 77.5	H3 = 50.0	N1 = 165	S = 100
D = 117	F1 = 36.0	H4 = 83.0	N2 = 130	T = 120